

版次 (Version)	变更内容 (Rev. Content)	变更者 (Change Person)

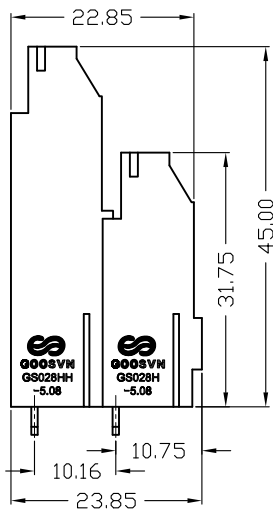
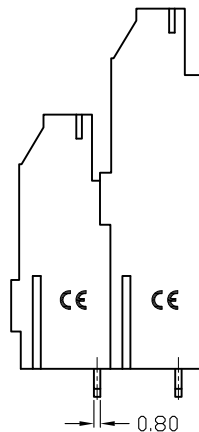
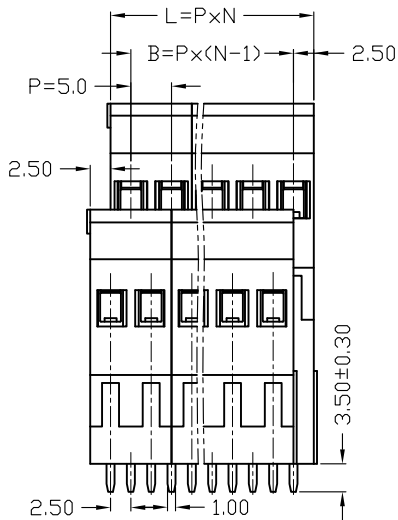
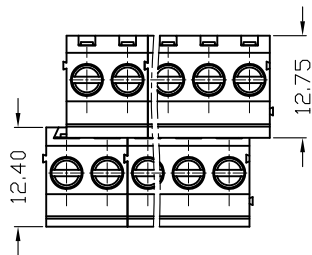
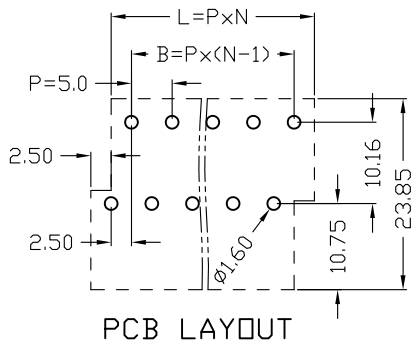

技术参数 (Technical Data)		
项目 (Item)	UL	IEC
额定电气参数 (Rated Electrical Parameters)	300V/20A	250V/20A
压线范围 (Wire Range)	26~12AWG	0.5~2.5mm ²
工频耐压 (Frequency Voltage)	AC 2000V	
冲击耐压 (Rated Surge Voltage)	4000V	
绝缘阻抗 (Insulation Resistance)	DC500V 500MΩ above	
接触电阻 (Contact Resistance)	≤20mΩ	
剥线长度 (Stripping Length)	7mm	
工作温度 (Temperature)	-40°C~+105°C	
材质和电镀 (Material and plating)		
绝缘材质 (Housing)	PA66 (UL94 V-0)	
触点材料 (Contact)	铜合金, 镀锡 (Copper alloy, Sn plated)	
螺丝 (Screws)	钢, 镀锌 (Steel, Zn plated)	
方盒 (Cage)	铜合金, 镀镍 (Copper alloy, Ni plated)	

产品命名编码:

(Product Number Code):

GS028A2-5.0-2*XXP-1Y-00A (H)

产品型号 (Series No.)

极数 (No. of poles)

客户需求

(Customer Request)

塑体颜色 (Housing Color)

- 1: 单倍间距 (Single Pitch)
- 2: 双倍间距 (Double Pitch)

- 1: 绿色 (Green)
- 2: 蓝色 (Blue)
- 3: 黑色 (Black)
- 4: 灰色 (Grey)
- 5: 橙色 (Orange)
- 6: 红色 (Red)
- 7: 透明色 (Transparent)
- 8: 白色 (White)
- 9: 黄色 (Yellow)
- Y: 多种颜色 (Mixed Color)

P=5.0mm, N为孔位数 (N for hole digits), 有效位数为 (Significant Digits): 2*02P~2*XXP

N	2*02P	2*03P	2*04P	2*05P	2*06P	2*07P	2*08P	2*09P	2*10P	2*11P	2*12P	2*13P
L	10.00	15.00	20.00	25.00	30.00	35.00	40.00	45.00	50.00	55.00	60.00	65.00
B	5.00	10.00	15.00	20.00	25.00	30.00	35.00	40.00	45.00	50.00	55.00	60.00
N	2*14P	2*15P	2*16P	2*17P	2*18P	2*19P	2*20P	2*21P	2*22P	2*23P	2*24P	...
L	70.00	75.00	80.00	85.00	90.00	95.00	100.00	105.00	110.00	115.00	120.00	
B	65.00	70.00	75.00	80.00	85.00	90.00	95.00	100.00	105.00	110.00	115.00	



宁波高胜电子有限公司
NINGBO GOOSVN ELECTRONIC CO.,LTD

公差范围 (Tolerance Range)

150~	±1.50
60~150	±1.00
30~60	±0.60
6~30	±0.40
0~6	±0.25

型号 (Type): GS028A2-5.0-2*XXP-1Y-00A (H)

核准 (Approval):	图号 (Drawing NO.):
审核 (Audit):	单位 (Units): mm 页码 (Page): 1/1
设计 (Design):	比例 (Scale): FULL



版次 (Version): T0

版次 (Version)	变更内容 (Rev. Content)	变更者 (Change Person)

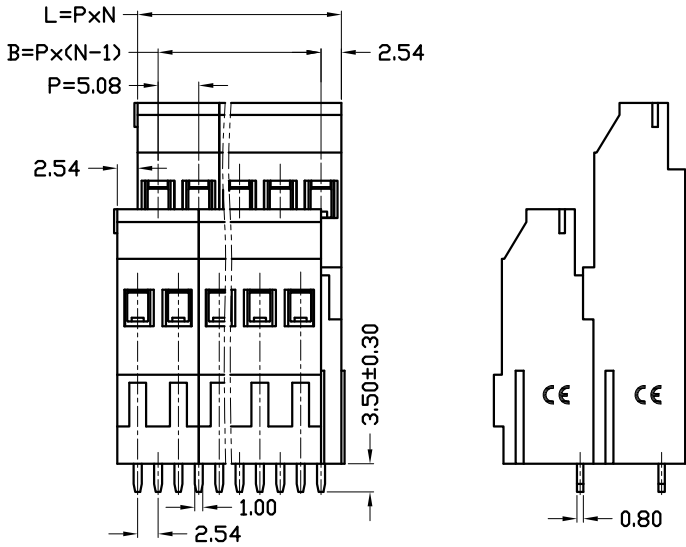
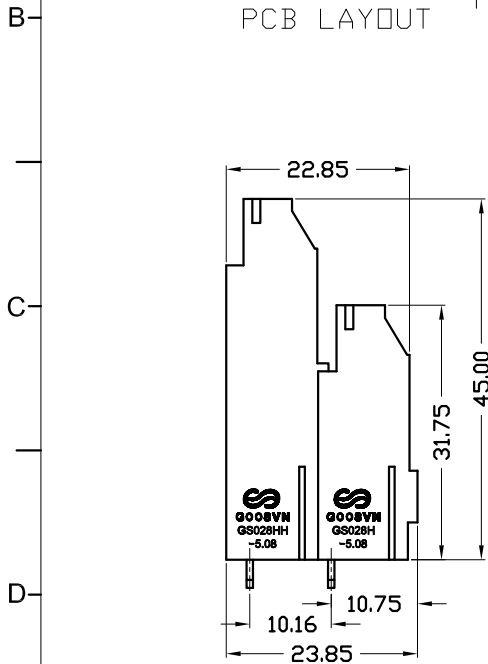
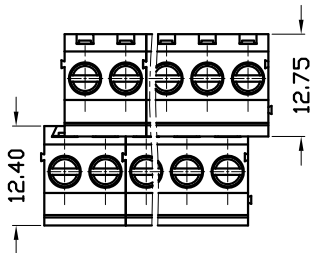
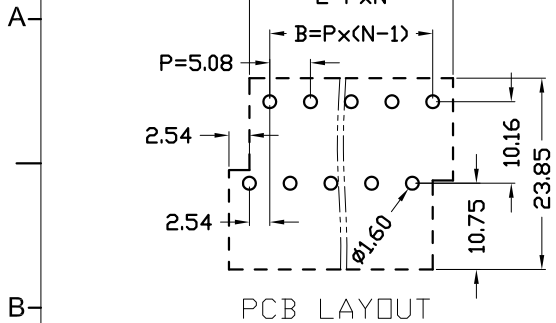

技术参数 (Technical Data)		
项 目 (Item)	UL	IEC
额定电气参数 (Rated Electrical Parameters)	300V/20A	250V/20A
压线范围 (Wire Range)	26~12AWG	0.5~2.5mm ²
工频耐压 (Frequency Voltage)	AC 2000V	
冲击耐压 (Rated Surge Voltage)	4000V	
绝缘阻抗 (Insulation Resistance)	DC500V 500MΩ above	
接触电阻 (Contact Resistance)	≤20mΩ	
剥线长度 (Stripping Length)	7mm	
工作温度 (Temperature)	-40°C~+105°C	
材质和电镀 (Material and plating)		
绝缘材质 (Housing)	PA66 (UL94 V-0)	
触点材料 (Contact)	铜合金, 镀锡 (Copper alloy, Sn plated)	
螺丝 (Screws)	钢, 镀锌 (Steel, Zn plated)	
方盒 (Cage)	铜合金, 镀镍 (Copper alloy, Ni plated)	

产品命名编码:
(Product Number Code):
GS028A2-5.08-2*XXP-1Y-00A (H)

产品型号 (Series No.) 客户需求 (Customer Request)
极数 (No. of poles) 塑体颜色 (Housing Color)

- | | |
|------------------------|-----------------------|
| 1: 单倍间距 (Single Pitch) | 7: 透明色 (Transparent) |
| 2: 双倍间距 (Double Pitch) | 8: 白色 (White) |
| | 9: 黄色 (Yellow) |
| | Y: 多种颜色 (Mixed Color) |
| | 6: 红色 (Red) |

P=5.08mm, N为孔位数 (N for hole digits), 有效位数为 (Significant Digits): 2*02P~2*XXP												
N	02P	03P	04P	05P	06P	07P	08P	09P	10P	11P	12P	13P
L	10.16	15.24	20.32	25.40	30.48	35.56	40.64	45.72	50.80	55.88	60.96	66.04
B	5.08	10.16	15.24	20.32	25.40	30.48	35.56	40.64	45.72	50.80	55.88	60.96
N	14P	15P	16P	17P	18P	19P	20P	21P	22P	23P	24P	...
L	71.12	76.20	81.28	86.36	91.44	96.52	101.60	106.68	111.76	116.84	121.92	
B	66.04	71.12	76.20	81.28	86.36	91.44	96.52	101.60	106.68	111.76	116.84	

宁波高胜电子有限公司 NINGBO GOOSVN ELECTRONIC CO.,LTD	公差范围 (Tolerance Range)	
	150~	±1.50
型号 (Type): GS028A2-5.08-2*XXP-1Y-00A (H)	60~150	±1.00
	30~60	±0.60
核准 (Approval):	6~30	±0.40
	0~6	±0.25
审核 (Audit):	角度 (Angle)	X ±2°
	XX	±1°
设计 (Design):	单位 (Units): mm	页码 (Page): 1/1
	比例 (Scale): FULL	版次 (Version): T0